

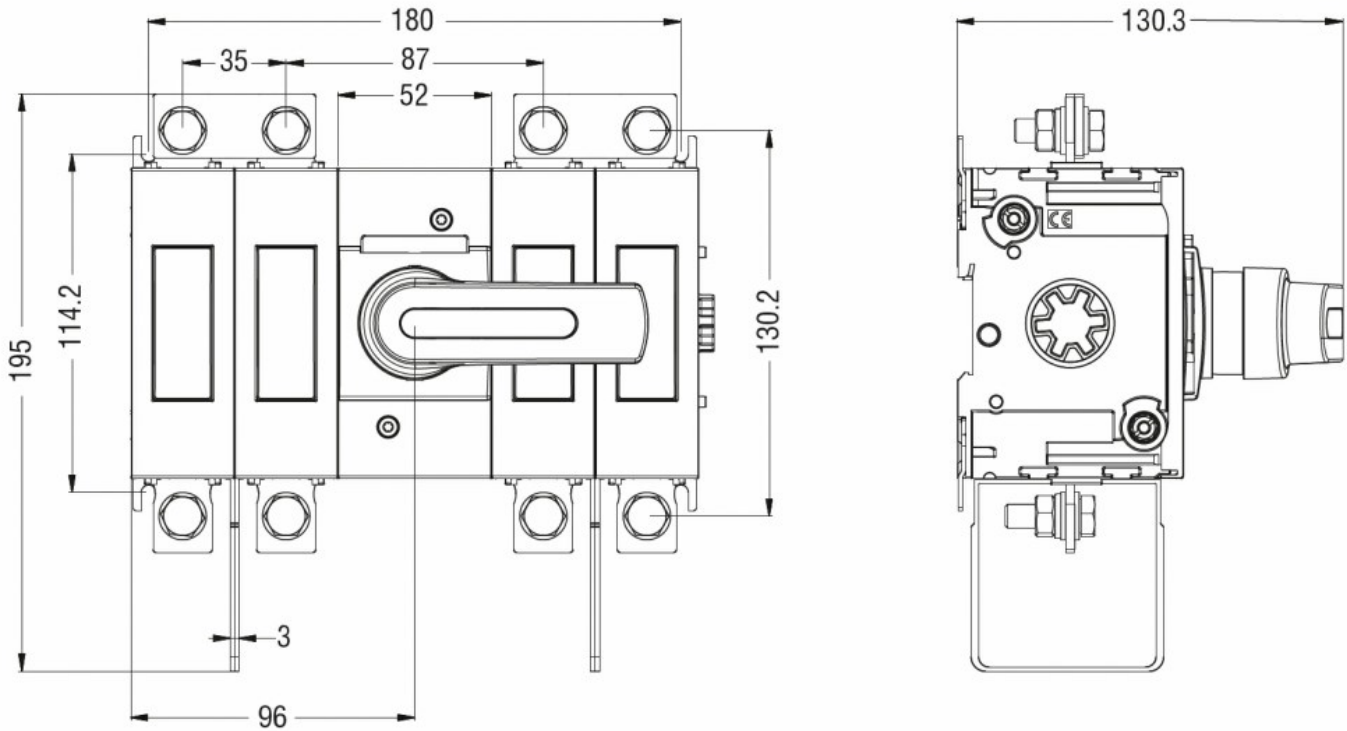

Product designation				Switch disconnecter
Product type designation				GLD
Number of poles		Nr.	4	
Operating voltage type				DC
Contact characteristics				
IEC Conventional free air thermal current I _{th}		A	100	
Rated insulation voltage U _i IEC/EN		V	1500	
Operating current I _e				
	DC21B			
		600V	A	100
		800V	A	100
		1000V	A	100
		1200V	A	100
		1500V	A	100
DCPV1				
		Operating current I _e 600V	A	100
		Operating current I _e 800V	A	100
		Operating current I _e 1200V	A	100
		Operating current I _e 1500V	A	100
	DCPV1			
		600V	A	100
		800V	A	100
		1200V	A	100
		1500V	A	100
Mechanical features				
Operating position		normal allowable	Vertical plan Any	
Fixing				Screw / DIN rail 35mm
Terminals		type	M8 x 25	
Tightening torque for terminals		min	Nm	15
		max	Nm	22
		min	lbin	132
		max	lbin	194
Conductor section		IEC min	mm ²	70
		IEC max	mm ²	185
		AWG/kcmil min		00
		AWG/kcmil max		400
Ambient conditions				
Operating temperature		min	°C	-25

Storage temperature	max	°C	+55
	min	°C	-40
Max altitude	max	°C	+70
		m	3000
Resistance & Protection			
Pollution degree	3		
Dimensions			



Wiring diagrams

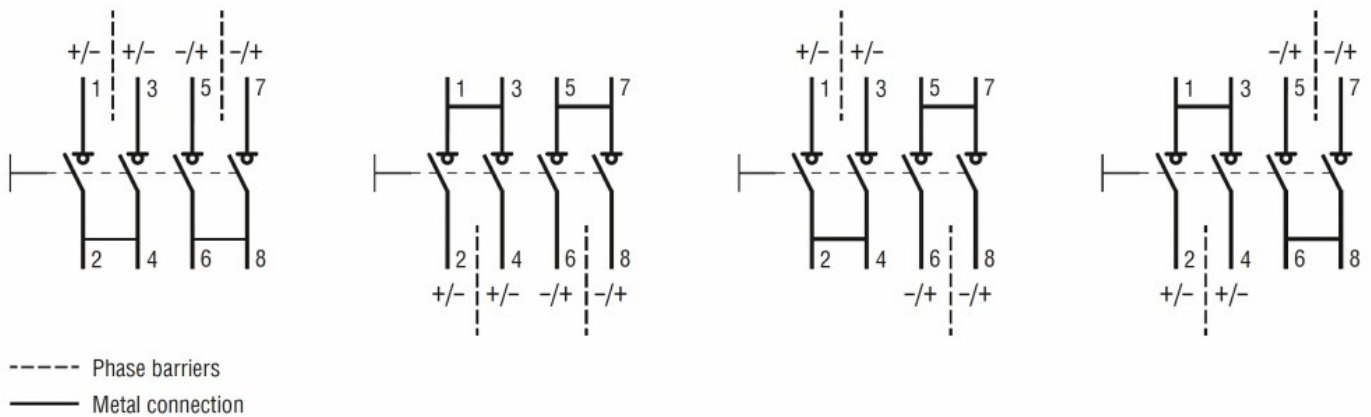

Certifications and compliance

Compliance	IEC/EN/BS 60947-1
	IEC/EN/BS 60947-3
	UL98B
Certifications	CE

ETIM classification

ETIM 8.0

EC000216 -
Switch
disconnector